



WE UNDERSTAND.

NEUROSURGERY

XABO[®]

ANTIBIOTIC IMPREGNATED CATHETERS
XTRA PROTECTION AGAINST INFECTION

INFECTIONS ARE A SERIOUS COMPLICATION OF SHUNT IMPLANTATION

The implantation of a ventriculoperitoneal shunt is the main treatment option for hydrocephalus patients but complications occur quite often and are burdensome for patients, their relatives as well as the neurosurgeons.

Surgery on the brain is perceived as a very demanding procedure by the patient and family members. When such a surgery is followed by severe and potentially life-threatening complications, fears may arise. One of the most common and potentially serious complications of hydrocephalus treatment is an infection of the shunt [1]. This complication affects pediatric as well as adult patients and impairs their quality of life, cognitive function, and shunt survival [2].

Shunt infections mostly require removal of the shunt, antibiotic treatment and reimplantation [2].

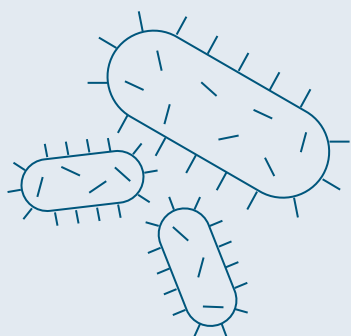

- » Bacterial shunt infection is one of the most common complications of shunt surgery, affecting 7-15% of hydrocephalus patients [3].





CONSEQUENCES OF SHUNT INFECTIONS

Shunt infections can have severe consequences for the patient: They are associated with a higher risk for further complications, such as seizures, psychomotor retardation, and shunt failure, which increase morbidity and mortality [6–9]. The removal of the infected shunt, antibiotic treatment and shunt re-implantation means two additional surgeries, which is an enormous burden both for the patient and the patient's family.

For the neurosurgeon, shunt infections drastically increase the workload and in the worst-case scenario require additional unplanned surgeries.

For the hospital, repeated shunt infections are associated with high economic losses and may affect the hospital's reputation. The costs for one adult patient amount to approximately \$50,000 per infection, with even higher costs for pediatric patients [10].



High associated costs



Lower shunt survival



Prolonged treatment



Emotional burden

- » Removal of the infected shunt and re-implantation is an enormous burden for patients and their families and means high economic losses for the hospital [10].

CAUSES OF BACTERIAL SHUNT INFECTIONS

Shunt infections are mainly caused by gram-positive bacteria, e.g. Staphylococcus species [4], and often occur within the first month after surgery [5].

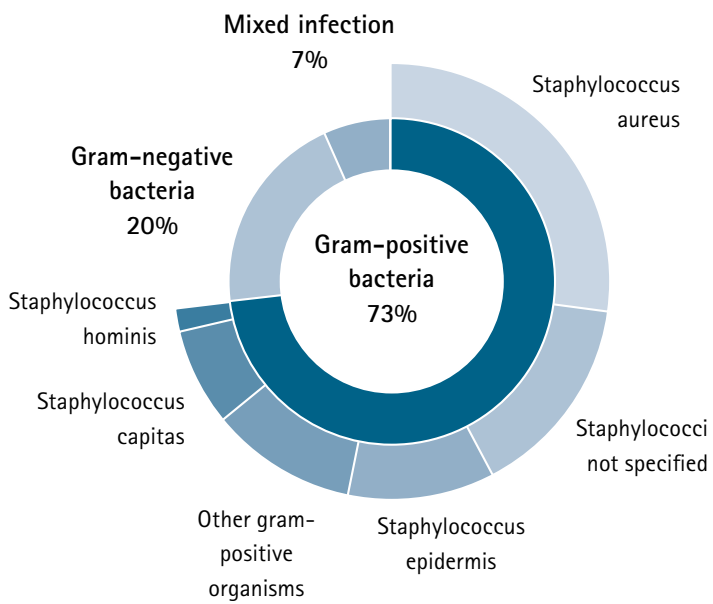

» 73% of all bacterial infections are caused by gram-positive pathogens [11].



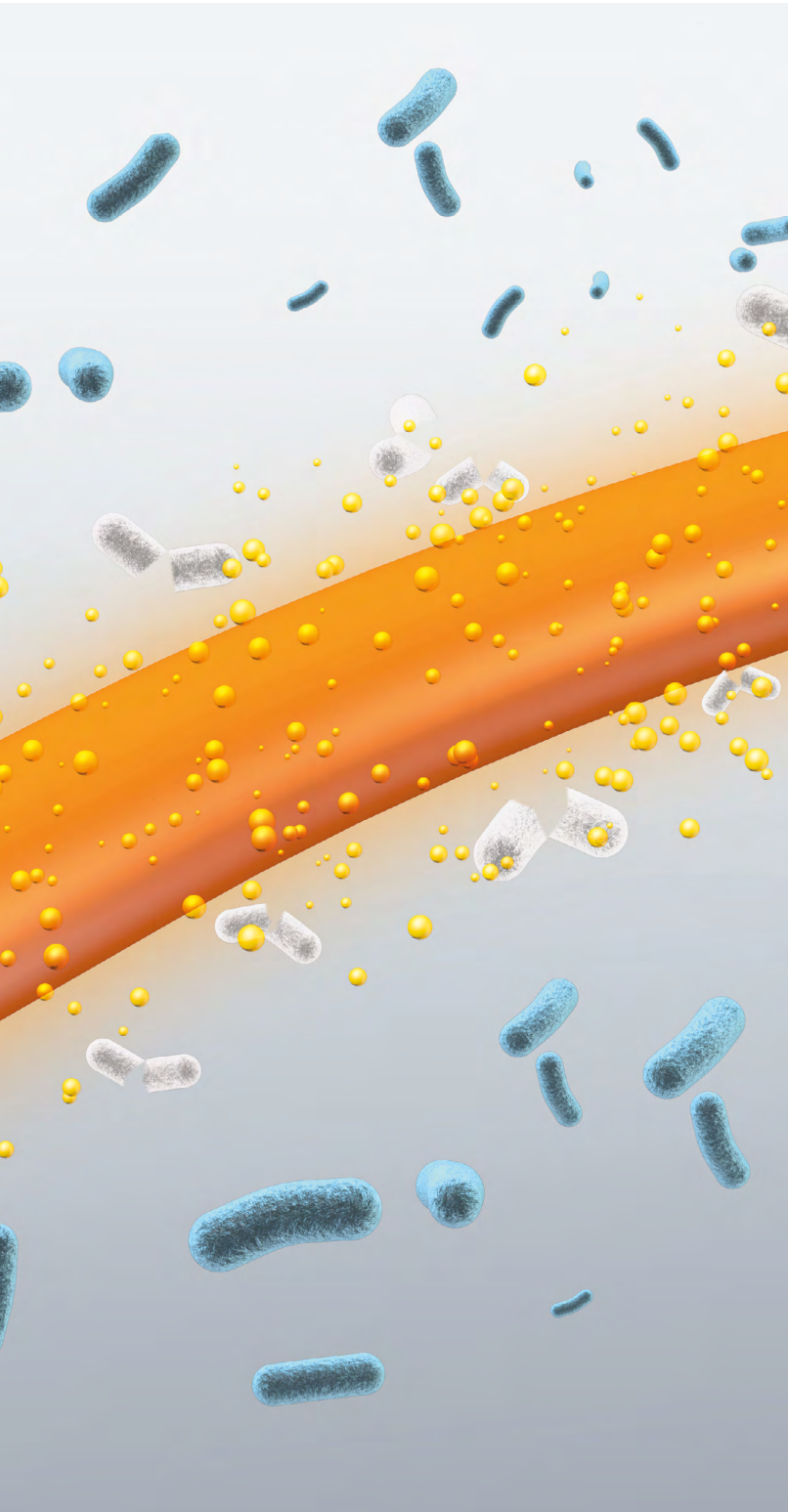

PREVENTION OF SHUNT INFECTIONS

Use of antibiotic-impregnated catheters can prevent two-thirds of shunt infections [11], thus helping to reduce patient burden and improve patient outcome. By avoiding additional hospital stays and surgeries the patient's wellbeing and the acceptance for the treatment can be increased. Moreover, as time-consuming complications are reduced, neurosurgeons can focus on their further work and thus help a greater number of patients. Prevention of infections also has a financial impact as it can save \$42,125 and \$230,390 per 100 first-time shunt placements in adult and pediatric patients, respectively [10].

Prevention of shunt infection can therefore help to reduce costs for hospitals and the health care system. In addition, follow-up operations can be avoided, thus easing the hospital staff's workload. The time saved and the reduced stress allow neurosurgeons to focus more on the individual patient, thus improving the treatment of hydrocephalus for every patient.

MIETHKE's new antibiotic-impregnated catheter XABO uses a balanced ratio of clindamycin hydrochloride and rifampicin to effectively fight gram-positive bacteria [12].

LASTING EFFECTS AND CONVENIENT HANDLING

XABO - GENTLE STERILIZATION, OPTIMIZED RELEASE KINETICS

XABO's initial antibiotic loading is retained thanks to the gentle sterilization process. In addition, XABO comes wrapped in a specifically designed complete package combination that minimizes degradation products [13], ensuring the antibiotic-impregnated catheter is kept in prime condition for longer. Patients can benefit from XABO's optimized release kinetics: the antibiotics are released continuously over at least 38 days after implantation [14], ensuring that XABO's antimicrobial activity covers the time window when the patient is most susceptible to infection [1, 15-17]. The high potency of the clindamycin hydrochloride and rifampicin impregnation allows for the release of low antibiotic doses, which prevents allergic reactions and minimizes the risk of resistance development.

Relation between drug load and time

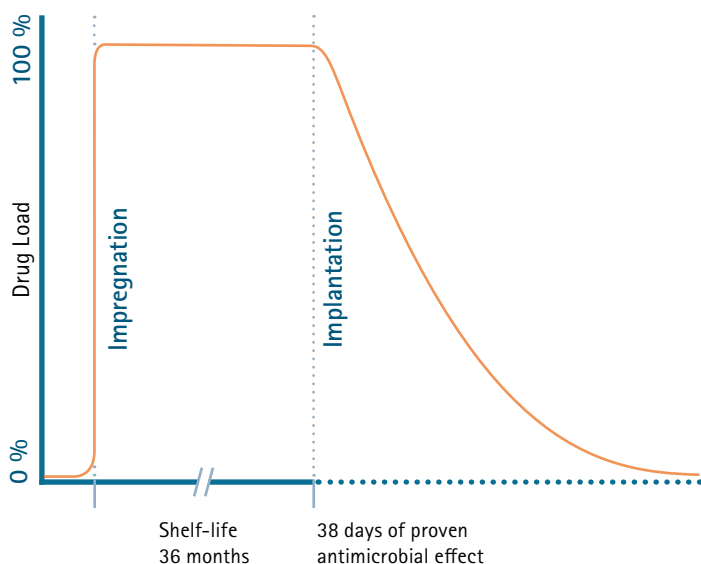

XABO - EASY HANDLING, CONVENIENT STORAGE

XABO is designed to simplify transport and storage: Thanks to the gentle sterilization process and safe packaging it is storable for up to 36 months and withstands temperatures up to 30°C without losing its effectiveness [18].

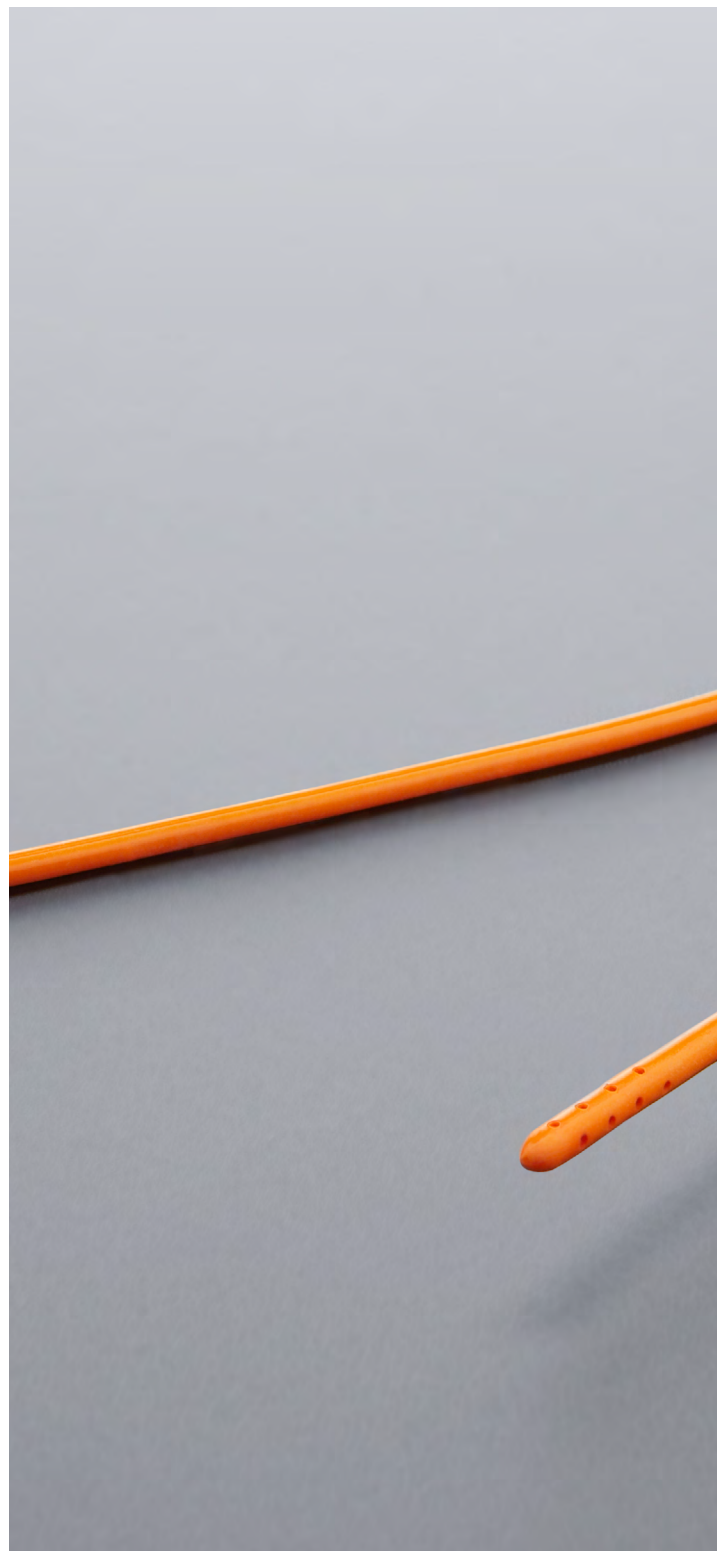



36 MONTHS

- » *XABO* catheters are the only antibiotic-impregnated catheters for hydrocephalus therapy with a shelf life of up to 36 months. This simplifies the clinical routine and the handling for the physician.

XABO®

HOLISTIC TREATMENT FOR HYDROCEPHALUS

» XABO offers long-lasting antimicrobial effects, easy handling, convenient storage and perfectly fits all our innovative MIETHKE valves.





M.blue® / M.blue plus® Shunt System XABO®

WITH PEDIATRIC CONTROL RESERVOIR

*An additional valve in the inlet of the pediatric CONTROL RESERVOIR makes it possible to pump cerebrospinal fluid in the direction of drainage only, allowing inspection of both the distal drainage section as well as the ventricular catheter

- M.blue valve with integrated pediatric CONTROL RESERVOIR and XABO distal catheter
- XABO ventricular catheter with introducing stylet and pediatric deflector (13 mm)

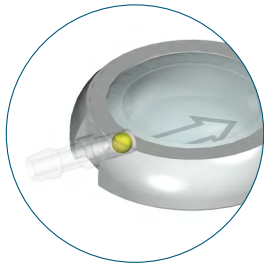
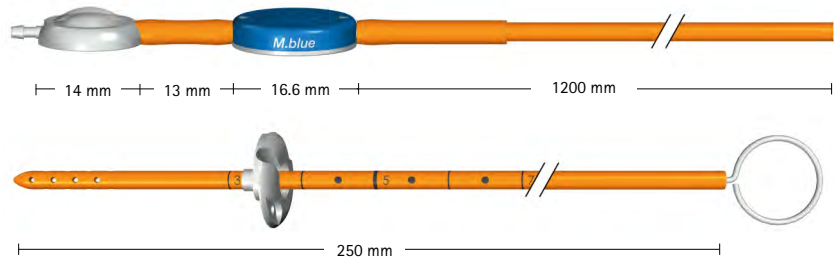

*pediatric CONTROL RESERVOIR

M.blue CONFIGURATIONS

Art. No.	Differential pressure unit	Gravitational unit **
FX815A	0 cmH ₂ O	0 - 40 cmH ₂ O
FX816A	5 cmH ₂ O	0 - 40 cmH ₂ O
FX817A	10 cmH ₂ O	0 - 40 cmH ₂ O
FX818A	15 cmH ₂ O	0 - 40 cmH ₂ O

- M.blue plus valve with integrated pediatric CONTROL RESERVOIR and XABO distal catheter
- XABO ventricular catheter with introducing stylet and pediatric deflector (13 mm)

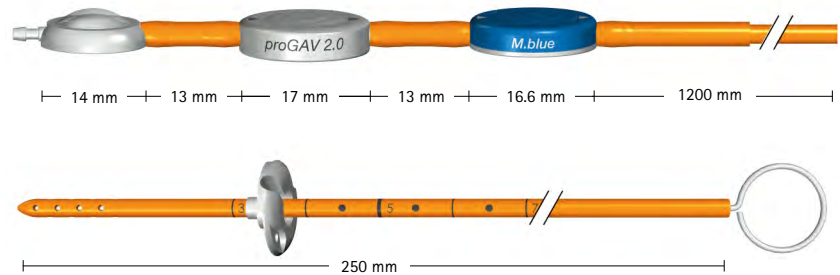

M.blue plus CONFIGURATION

Art. No.	Differential pressure unit ***	Gravitational unit **
FX819A	0 - 20 cmH ₂ O	0 - 40 cmH ₂ O

Connector: $d_o = 1.9$ mm
M.blue: $h = 4.2$ mm
proGAV 2.0: $h = 4.5$ mm
Catheters: $d_i = 1.2$ mm
 $d_o = 2.5$ mm

** preset to 20 cmH₂O

*** preset to 5 cmH₂O

M.blue® / M.blue plus® Shunt System XABO®



WITH PEDIATRIC SPRUNG RESERVOIR

* An additional valve in the inlet of the pediatric SPRUNG RESERVOIR makes it possible to pump cerebrospinal fluid in the direction of drainage only, allowing inspection of both the distal drainage section as well as the ventricular catheter

- M.blue valve with XABO distal catheter
- Pediatric SPRUNG RESERVOIR with XABO distal catheter
- XABO ventricular catheter with introducing stylet

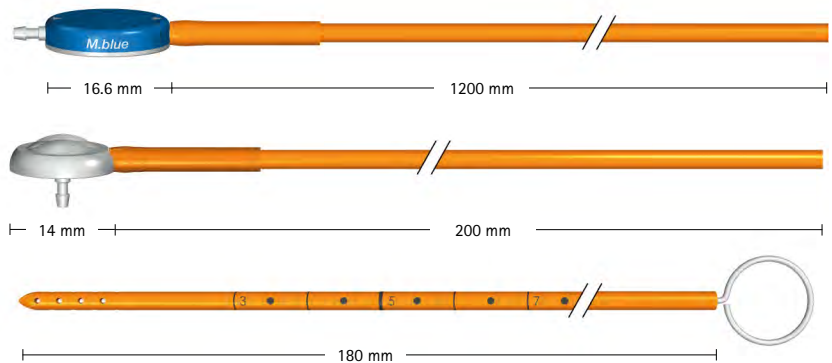

M.blue CONFIGURATIONS

Art. No.	Differential pressure unit	Gravitational unit **
FX835A	0 cmH ₂ O	0 - 40 cmH ₂ O
FX836A	5 cmH ₂ O	0 - 40 cmH ₂ O
FX837A	10 cmH ₂ O	0 - 40 cmH ₂ O
FX838A	15 cmH ₂ O	0 - 40 cmH ₂ O

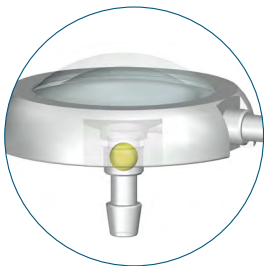

*pediatric SPRUNG RESERVOIR

- M.blue plus valve with XABO distal catheter
- Pediatric SPRUNG RESERVOIR with XABO distal catheter
- XABO ventricular catheter with introducing stylet

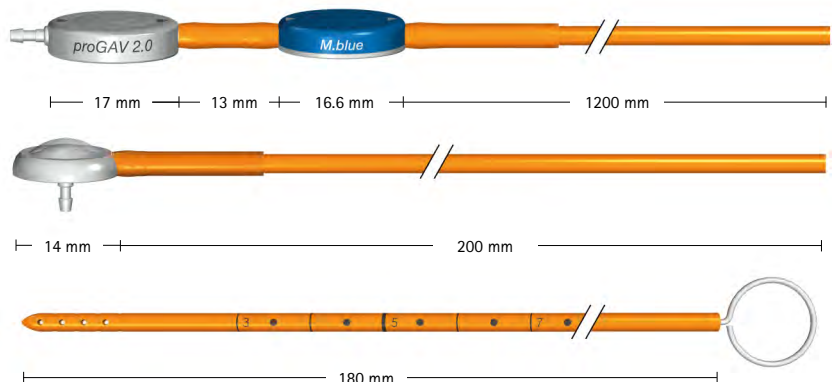

M.blue plus CONFIGURATION

Art. No.	Differential pressure unit ***	Gravitational unit **
FX839A	0 - 20 cmH ₂ O	0 - 40 cmH ₂ O

Connector: $d_o = 1.9$ mm
M.blue: $h = 4.2$ mm
proGAV 2.0: $h = 4.5$ mm
Catheters: $d_i = 1.2$ mm
 $d_o = 2.5$ mm

** preset to 20 cmH₂O

*** preset to 5 cmH₂O

M.blue® / M.blue plus® Shunt System XABO®

WITH SPRUNG RESERVOIR

*An additional valve in the inlet of the SPRUNG RESERVOIR makes it possible to pump cerebrospinal fluid in the direction of drainage only, allowing inspection of both the distal drainage section as well as the ventricular catheter

- M.blue valve with XABO distal catheter
- SPRUNG RESERVOIR with XABO distal catheter
- XABO ventricular catheter with introducing stylet

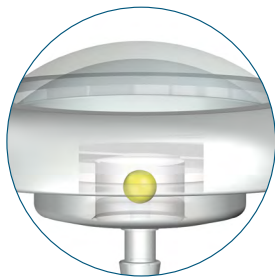

*SPRUNG RESERVOIR

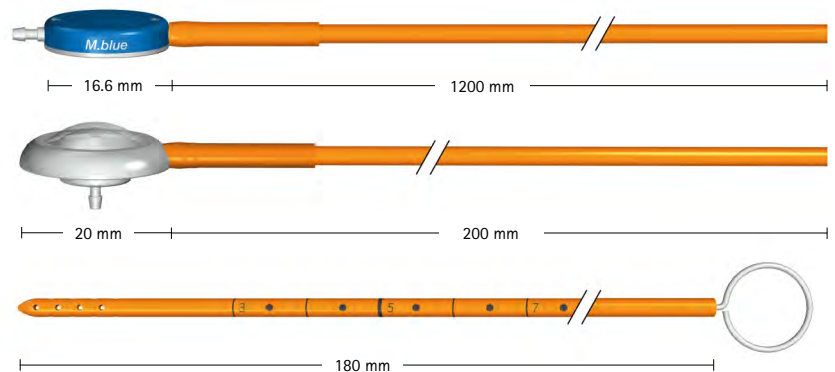

M.blue CONFIGURATIONS

Art. No.	Differential pressure unit	Gravitational unit **
FX840A	0 cmH ₂ O	0 - 40 cmH ₂ O
FX841A	5 cmH ₂ O	0 - 40 cmH ₂ O
FX842A	10 cmH ₂ O	0 - 40 cmH ₂ O
FX843A	15 cmH ₂ O	0 - 40 cmH ₂ O

- M.blue plus valve with XABO distal catheter
- SPRUNG RESERVOIR with XABO distal catheter
- XABO ventricular catheter with introducing stylet and pediatric deflector (13 mm)

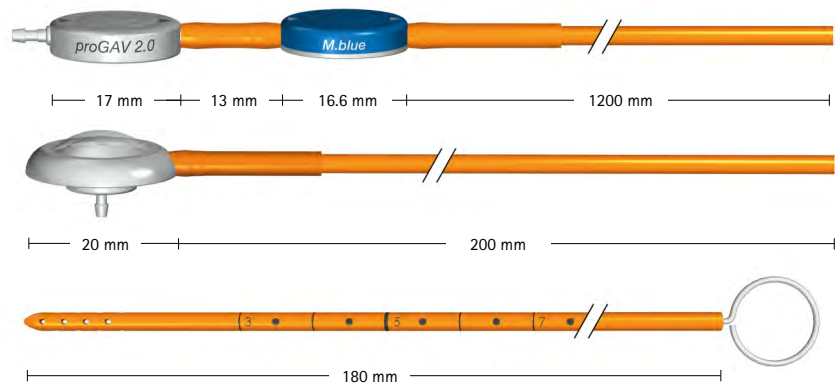

M.blue plus CONFIGURATION

Art. No.	Differential pressure unit ***	Gravitational unit **
FX844A	0 - 20 cmH ₂ O	0 - 40 cmH ₂ O

Connector: $d_o = 1.9$ mm
M.blue: $h = 4.2$ mm
proGAV 2.0: $h = 4.5$ mm
Catheters: $d_i = 1.2$ mm
 $d_o = 2.5$ mm

** preset to 20 cmH₂O

*** preset to 5 cmH₂O

proGAV® 2.0 Shunt System XABO®

WITH PEDIATRIC CONTROL RESERVOIR

*An additional valve in the inlet of the pediatric CONTROL RESERVOIR makes it possible to pump cerebrospinal fluid in the direction of drainage only, allowing inspection of both the distal drainage section as well as the ventricular catheter

- proGAV 2.0 valve with integrated pediatric CONTROL RESERVOIR and XABO distal catheter
- XABO ventricular catheter with introducing stylet and pediatric deflector (13 mm)

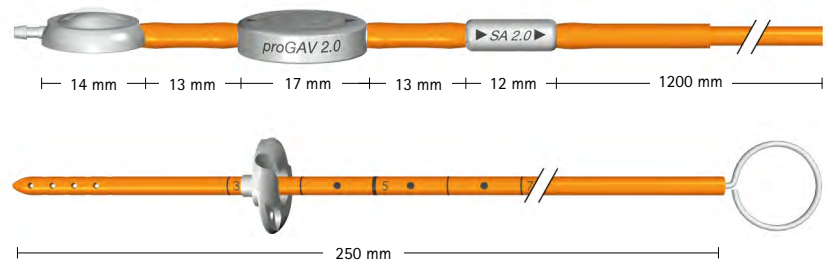

Connector: $d_o = 1.9$ mm
 proGAV 2.0: $h = 4.5$ mm
 SA 2.0: $d_o = 4.2$ mm
 Catheters: $d_i = 1.2$ mm
 $d_o = 2.5$ mm

** preset to 5 cmH₂O

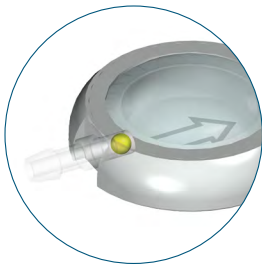

*pediatric CONTROL RESERVOIR

STANDARD CONFIGURATIONS

Art. No.	Differential pressure unit **	Gravitational unit
FX609A	0 - 20 cmH ₂ O	20 cmH ₂ O
FX610A	0 - 20 cmH ₂ O	25 cmH ₂ O

ALTERNATIVE CONFIGURATIONS

Art. No.	Differential pressure unit **	Gravitational unit
FX607A	0 - 20 cmH ₂ O	10 cmH ₂ O
FX608A	0 - 20 cmH ₂ O	15 cmH ₂ O
FX611A	0 - 20 cmH ₂ O	30 cmH ₂ O
FX612A	0 - 20 cmH ₂ O	35 cmH ₂ O

proGAV® 2.0 Shunt System XABO®

WITH PEDIATRIC SPRUNG RESERVOIR



* An additional valve in the inlet of the pediatric SPRUNG RESERVOIR makes it possible to pump cerebrospinal fluid in the direction of drainage only, allowing inspection of both the distal drainage section as well as the ventricular catheter

- proGAV 2.0 valve with XABO distal catheter
- Pediatric SPRUNG RESERVOIR with XABO distal catheter
- XABO ventricular catheter with introducing stylet

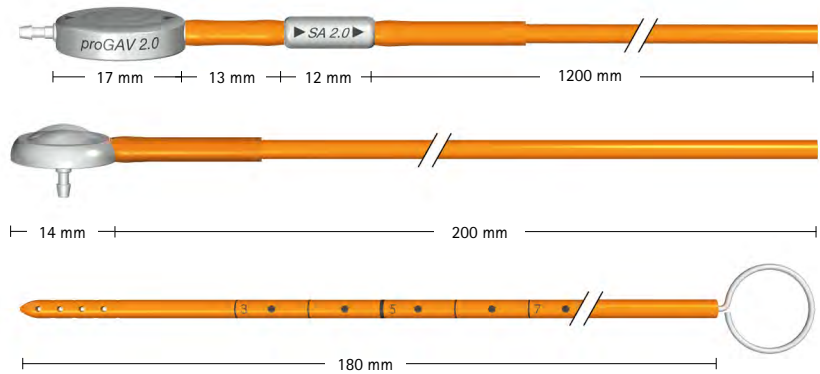

Connector: $d_o = 1.9$ mm
 proGAV 2.0: $h = 4.5$ mm
 SA 2.0: $d_o = 4.2$ mm
 Catheters: $d_i = 1.2$ mm
 $d_o = 2.5$ mm

** preset to 5 cmH₂O

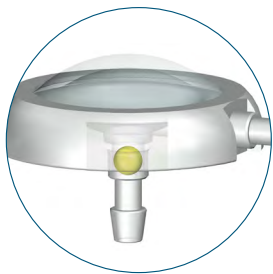

*pediatric SPRUNG RESERVOIR

STANDARD CONFIGURATIONS

Art. No.	Differential pressure unit **	Gravitational unit
FX583A	0 - 20 cmH ₂ O	20 cmH ₂ O
FX584A	0 - 20 cmH ₂ O	25 cmH ₂ O

ALTERNATIVE CONFIGURATIONS

Art. No.	Differential pressure unit **	Gravitational unit
FX581A	0 - 20 cmH ₂ O	10 cmH ₂ O
FX582A	0 - 20 cmH ₂ O	15 cmH ₂ O
FX585A	0 - 20 cmH ₂ O	30 cmH ₂ O
FX586A	0 - 20 cmH ₂ O	35 cmH ₂ O

proGAV[®] 2.0 Shunt System XABO[®]

WITH SPRUNG RESERVOIR

* An additional valve in the inlet of the SPRUNG RESERVOIR makes it possible to pump cerebrospinal fluid in the direction of drainage only, allowing inspection of both the distal drainage section as well as the ventricular catheter

- proGAV 2.0 valve with XABO distal catheter
- SPRUNG RESERVOIR with XABO distal catheter
- XABO ventricular catheter with introducing stylet

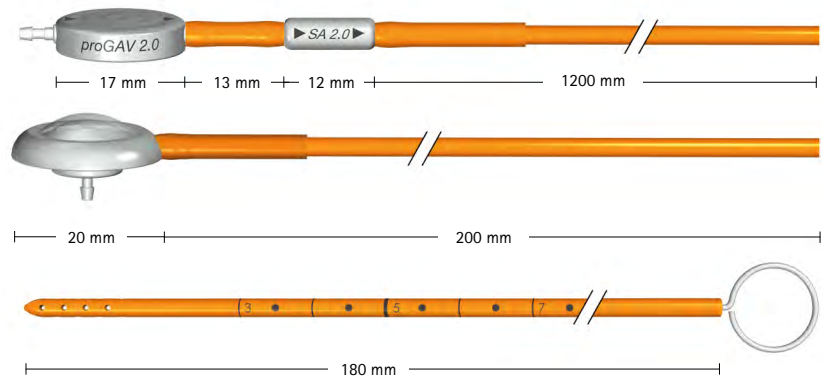

Connector: $d_o = 1.9$ mm
 proGAV 2.0: $h = 4.5$ mm
 SA 2.0: $d_o = 4.2$ mm
 Catheters: $d_i = 1.2$ mm
 $d_o = 2.5$ mm

** preset to 5 cmH₂O

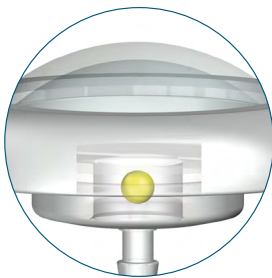

*SPRUNG RESERVOIR

STANDARD CONFIGURATIONS

Art. No.	Differential pressure unit **	Gravitational unit
FX576A	0 - 20 cmH ₂ O	20 cmH ₂ O
FX577A	0 - 20 cmH ₂ O	25 cmH ₂ O

ALTERNATIVE CONFIGURATIONS

Art. No.	Differential pressure unit **	Gravitational unit
FX574A	0 - 20 cmH ₂ O	10 cmH ₂ O
FX575A	0 - 20 cmH ₂ O	15 cmH ₂ O
FX578A	0 - 20 cmH ₂ O	30 cmH ₂ O
FX579A	0 - 20 cmH ₂ O	35 cmH ₂ O

- *M.blue plus* Instrument Set
- *M.blue plus* Compass
- *M.blue plus* Adjustment ring
- *M.blue plus* Adjustment assistant

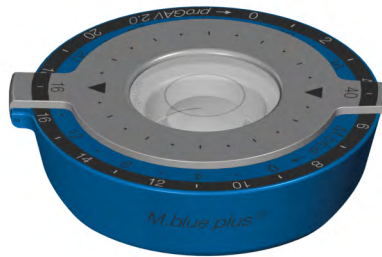

M.blue plus Compass

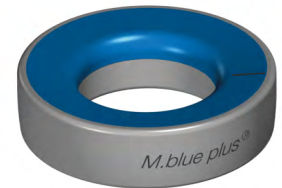

M.blue plus Adjustment ring



M.blue plus Adjustment assistant

Art. Nr.	Instruments
FX890T	<i>M.blue plus</i> Instrument Set (includes FX891T and FX892T)
FX891T	<i>M.blue plus</i> Compass
FX892T	<i>M.blue plus</i> Adjustment ring
FX893T	<i>M.blue plus</i> Adjustment assistant

GAV[®] 2.0 Shunt System XABO[®]

WITH PEDIATRIC CONTROL RESERVOIR

*An additional valve in the inlet of the pediatric CONTROL RESERVOIR makes it possible to pump cerebrospinal fluid in the direction of drainage only, allowing inspection of both the distal drainage section as well as the ventricular catheter

- GAV 2.0 valve with integrated pediatric CONTROL RESERVOIR and XABO distal catheter
- XABO ventricular catheter with introducing stylet and pediatric deflector (13 mm)

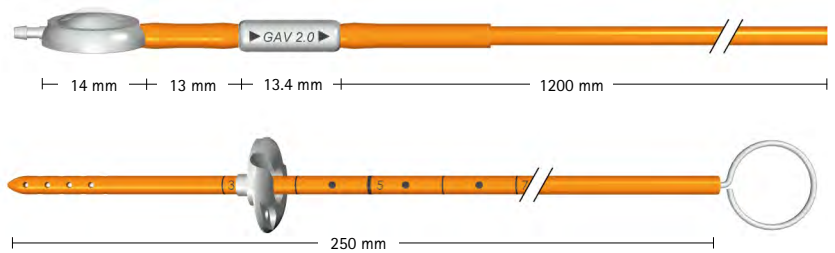

Connector: $d_o = 1.9$ mm
 Valve: $d_o = 4.2$ mm
 Catheters: $d_i = 1.2$ mm
 $d_o = 2.5$ mm

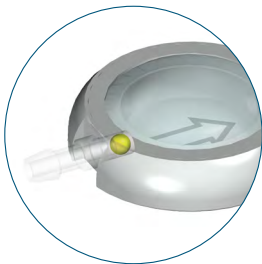

*pediatric CONTROL RESERVOIR

CONFIGURATIONS

Art. No.	lying	upright
FX152A	5 cmH ₂ O	20 cmH ₂ O
FX153A	5 cmH ₂ O	25 cmH ₂ O
FX154A	5 cmH ₂ O	30 cmH ₂ O
FX155A	5 cmH ₂ O	35 cmH ₂ O
FX156A	10 cmH ₂ O	25 cmH ₂ O
FX157A	10 cmH ₂ O	30 cmH ₂ O

GAV® 2.0 Shunt System XABO®

WITH PEDIATRIC SPRUNG RESERVOIR



*An additional valve in the inlet of the pediatric SPRUNG RESERVOIR makes it possible to pump cerebrospinal fluid in the direction of drainage only, allowing inspection of both the distal drainage section as well as the ventricular catheter

- GAV 2.0 valve with XABO distal catheter
- Pediatric SPRUNG RESERVOIR with XABO distal catheter
- XABO ventricular catheter with introducing stylet

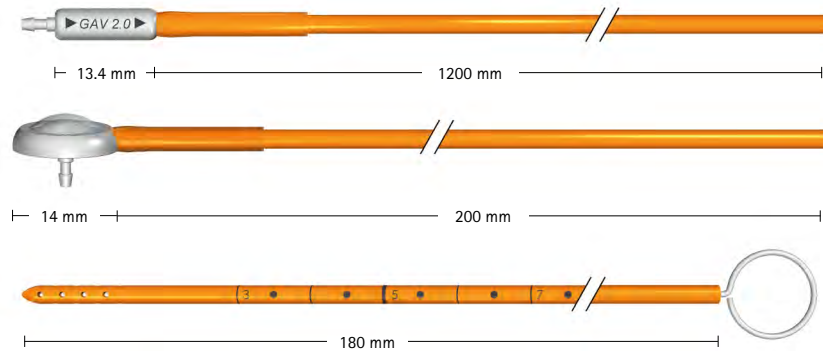

Connector: $d_o = 1.9 \text{ mm}$
 Valve: $d_o = 4.2 \text{ mm}$
 Catheters: $d_i = 1.2 \text{ mm}$
 $d_o = 2.5 \text{ mm}$

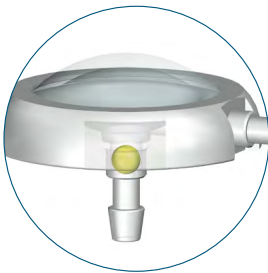

*pediatric SPRUNG RESERVOIR

CONFIGURATIONS

Art. No.	lying	upright
FX276A	5 cmH ₂ O	20 cmH ₂ O
FX277A	5 cmH ₂ O	25 cmH ₂ O
FX278A	5 cmH ₂ O	30 cmH ₂ O
FX279A	5 cmH ₂ O	35 cmH ₂ O
FX280A	10 cmH ₂ O	25 cmH ₂ O
FX281A	10 cmH ₂ O	30 cmH ₂ O

GAV[®] 2.0 plus Shunt System XABO[®]

WITH SPRUNG RESERVOIR

*An additional valve in the inlet of the SPRUNG RESERVOIR makes it possible to pump cerebrospinal fluid in the direction of drainage only, allowing inspection of both the distal drainage section as well as the ventricular catheter

- GAV 2.0 valve with XABO distal catheter
- SPRUNG RESERVOIR with XABO distal catheter
- XABO ventricular catheter with introducing stylet

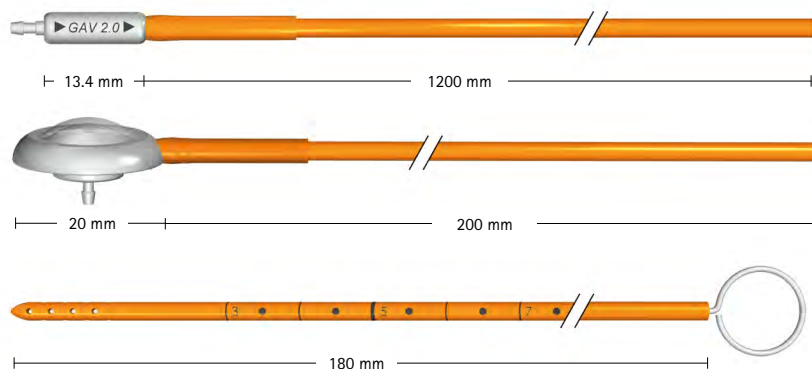

Connector: $d_o = 1.9$ mm
 Valve: $d_o = 4.2$ mm
 Catheters: $d_i = 1.2$ mm
 $d_o = 2.5$ mm

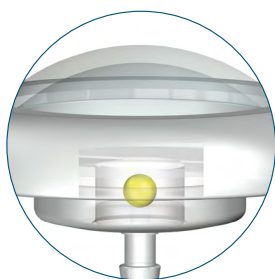

*SPRUNG RESERVOIR

CONFIGURATIONS

Art. No.	lying	upright
FX270A	5 cmH ₂ O	20 cmH ₂ O
FX271A	5 cmH ₂ O	25 cmH ₂ O
FX272A	5 cmH ₂ O	30 cmH ₂ O
FX274A	5 cmH ₂ O	35 cmH ₂ O
FX274A	10 cmH ₂ O	25 cmH ₂ O
FX275A	10 cmH ₂ O	30 cmH ₂ O

XABO® Catheters

- Impregnated with Clindamycin hydrochloride (0.15 weight %) and Rifampicin (0.054 weight %)
- Catheters are made of radiopaque silicone
- Inner diameter 1.2 mm
- Outer diameter 2.5 mm



PERITONEAL CATHETER

Art. No.	Length
FY010A	600 mm
FY011A	900 mm
FY012A	1200 mm

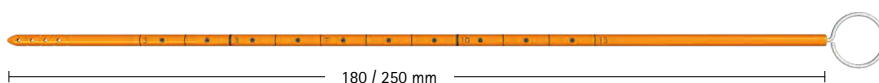

VENTRICULAR CATHETER

Art. No.	Length
FY020A	180 mm
FY021A	250 mm



Deflector



VENTRICULAR CATHETER WITH DEFLECTOR

Art. No.	Length	Deflector diameter
FY022A	180 mm	16 mm
FY023A	250 mm	16 mm



pediatric deflector



VENTRICULAR CATHETER WITH PEDIATRIC DEFLECTOR

Art. No.	Length	Deflector diameter
FY024A	180 mm	13 mm
FY025A	250 mm	13 mm

- Set contains one ventricular catheter and one peritoneal catheter

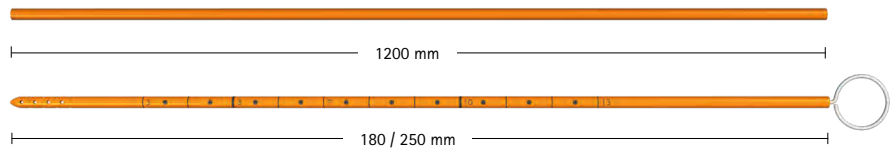

CATHETER SET

Art. No.	Ventricular Catheter	Peritoneal Catheter
FY040A	180 mm	1200 mm
FY041A	250 mm	1200 mm



Deflector

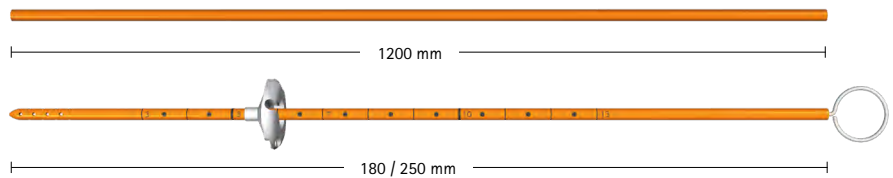

CATHETER SET WITH DEFELECTOR

Art. No.	Ventricular Catheter	Peritoneal Catheter
FY042A	180 mm	1200 mm
FY043A	250 mm	1200 mm



pediatric deflector

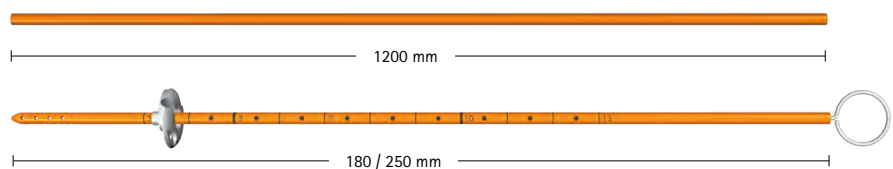







CATHETER SET WITH PEDIATRIC DEFELECTOR

Art. No.	Ventricular Catheter	Peritoneal Catheter
FY044A	180 mm	1200 mm
FY045A	250 mm	1200 mm

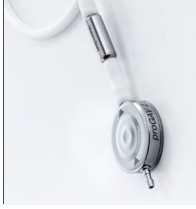
OUR SHUNT SYSTEMS – YOUR CHOICE

OUR SHUNT SYSTEMS

	<i>M.blue</i> [®]	<i>M.blue plus</i> [®]	<i>proGAV</i> [®] 2.0	<i>GAV</i> [®] 2.0	SHUNT- ASSISTANT [®] 2.0	<i>miniNAV</i> [®]	Accessories
							
Description	Adjustable gravitational valve with integrated differential pressure unit	Adjustable differential pressure valve with adjustable gravitational unit	Adjustable differential pressure valve with gravitational unit	Gravitational valve for the treatment of hydrocephalus	Gravitational unit for integration into shunt systems in order to avoid excess drainage	Differential pressure valve, specifically for premature babies and newborns or bedridden or non-mobile patients	
Indication							
NPH	✓	✓	✓	✓	✓		
Pediatric HC	✓	✓	✓	✓	✓	✓	
Adult HC	✓	✓	✓	✓	✓	✓	
Patient							
Bedridden	✓	✓				✓	
Active	✓	✓	✓	✓	✓	*	
Feature							
3-Tesla MR Conditional	✓	✓	✓	✓	✓	✓	
Gravitational unit	✓	✓	✓	✓	✓		
Adjustable	✓	✓	✓				
LP				✓	✓		
XABO [®]	✓	✓	✓	✓			✓

REFERENCES

- 1 Okamura Y, Maruyama K, Fukuda S, et al. Detailed standardized protocol to prevent cerebrospinal fluid shunt infection. *J Neurosurg* 2019;1–5.
- 2 Vinchon M, Dhellemmes P. Cerebrospinal fluid shunt infection: risk factors and long-term follow-up. *Childs Nerv Syst* 2006;22(7):692–97.
- 3 Fernández-Méndez R, Richards HK, Seeley HM, et al. Current epidemiology of cerebrospinal fluid shunt surgery in the UK and Ireland (2004–2013). *J Neurol Neurosurg Psychiatry* 2019;90(7):747–54.
- 4 Prusseit J, Simon M, Brelie C von der, et al. Epidemiology, prevention and management of ventriculoperitoneal shunt infections in children. *Pediatr Neurosurg* 2009;45(5):325–36.
- 5 Wu Y, Green NL, Wrench MR, et al. Ventriculoperitoneal shunt complications in California: 1990 to 2000. *Neurosurgery* 2007;61(3):557–62; discussion 562–3.
- 6 Blount JP, Campbell JA, Haines SJ. Complications in Ventricular Cerebrospinal Fluid Shunting. *Neurosurgery Clinics of North America* 1993;4(4):633–56.
- 7 Darouiche RO. Treatment of infections associated with surgical implants. *N Engl J Med* 2004;350(14):1422–29.
- 8 Walters BC, Hoffman HJ, Hendrick EB, et al. Cerebrospinal fluid shunt infection. Influences on initial management and subsequent outcome. *J Neurosurg* 1984;60(5):1014–21.
- 9 Sciubba DM, Stuart RM, McGirt MJ, et al. Effect of antibiotic-impregnated shunt catheters in decreasing the incidence of shunt infection in the treatment of hydrocephalus. *J Neurosurg* 2005;103(2 Suppl):131–36.
- 10 Parker SL, McGirt MJ, Murphy JA, et al. Cost savings associated with antibiotic-impregnated shunt catheters in the treatment of adult and pediatric hydrocephalus. *World Neurosurg* 2015;83(3):382–86.
- 11 Mallucci CL, Jenkinson MD, Conroy EJ, et al. Antibiotic or silver versus standard ventriculoperitoneal shunts (BASICS): a multicentre, single-blinded, randomised trial and economic evaluation. *The Lancet* 2019;394(10208):1530–39.
- 12 MIETHKE report. Data on file.
- 13 MIETHKE report. Data on file.
- 14 MIETHKE report. Data on file.
- 15 Borgbjerg BM, Gjerris F, Albeck MJ, Børgesen SE. Risk of infection after cerebrospinal fluid shunt: an analysis of 884 first-time shunts. *Acta Neurochir (Wien)*. 1995;136(1–2):1–7.
- 16 George R, Leibrock L, Epstein M. Long-term analysis of cerebrospinal fluid shunt infections. A 25-year experience. *J Neurosurg*. 1979;51(6):804–811.
- 17 Wells DL, Allen JM. Ventriculoperitoneal shunt infections in adult patients. *AACN Adv Crit Care*. 2013;24(1):6–14.
- 18 MIETHKE report. Data on file.



NEUROSURGERY

WE UNDERSTAND THE GRAVITY OF THE SITUATION.

MIETHKE GRAVITATIONAL VALVES

AESCULAP® – a B. Braun brand

Distributed by

Aesculap AG | Am Aesculap-Platz | 78532 Tuttlingen | Germany

Phone +49 7461 95-0 | Fax +49 7461 95-2600 | www.aesculap.com

AESFULAP® – a B. Braun brand

Manufacturer acc. to MDD 93/42/EEC

Christoph Miethke GmbH & Co. KG | Ulanenweg 2 | 14469 Potsdam | Germany

Phone +49 331 62083-0 | Fax +49 331 62083-40 | www.miethke.com



The product trademarks "XABO", "M.blue", "M.blue plus", "proGAV", "GAV" and "SHUNTASSISTANT" are registered trademarks of Miethke GmbH & Co. KG. The main product trademark "Aesculap" is a registered trademark of Aesculap AG.

Subject to technical changes. All rights reserved. This brochure may only be used for the exclusive purpose of obtaining information about our products. Reproduction in any form partial or otherwise is not permitted.